

Checklist - Sheet 5 - System layouts

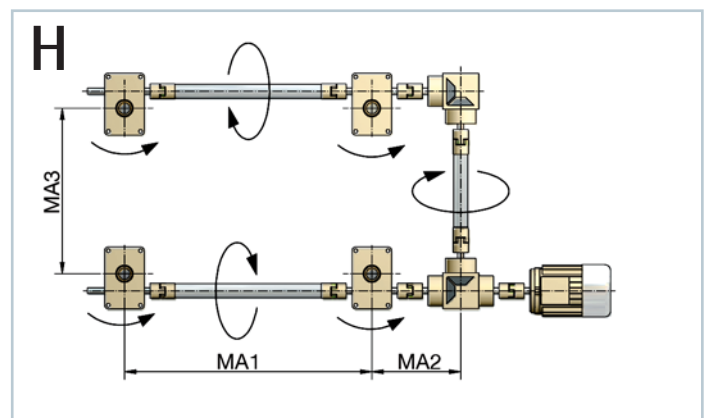

The most common layouts are shown. If your design is different, be sure to check the direction of rotation!

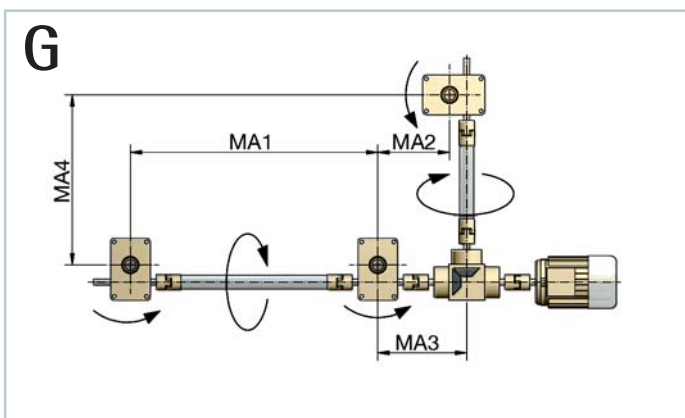
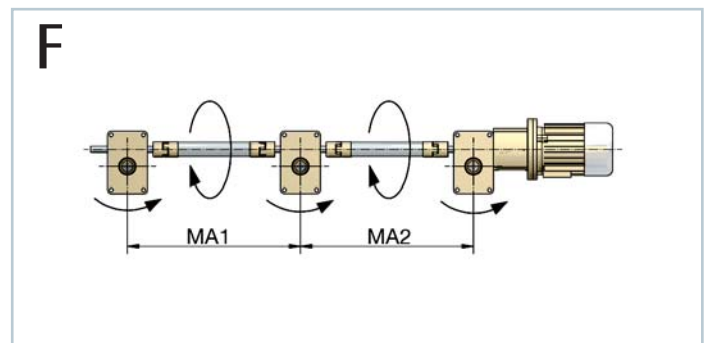
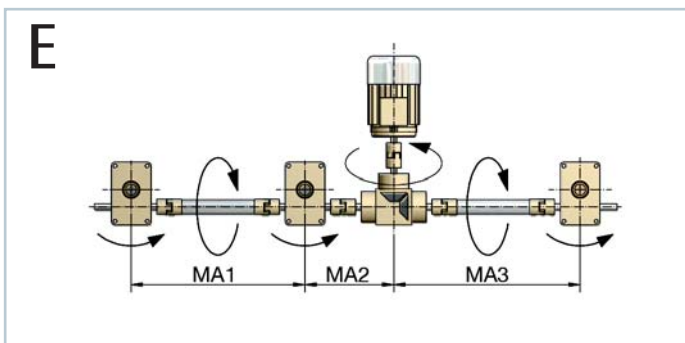
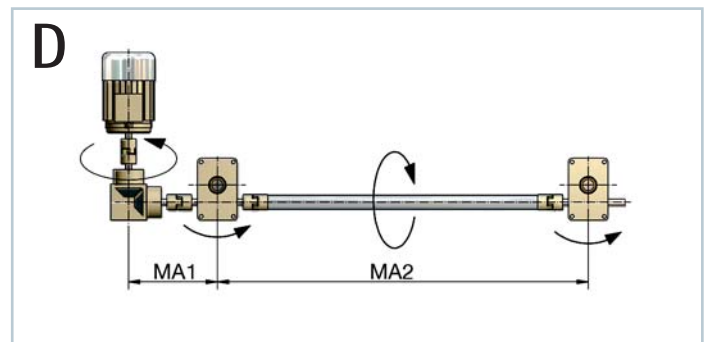
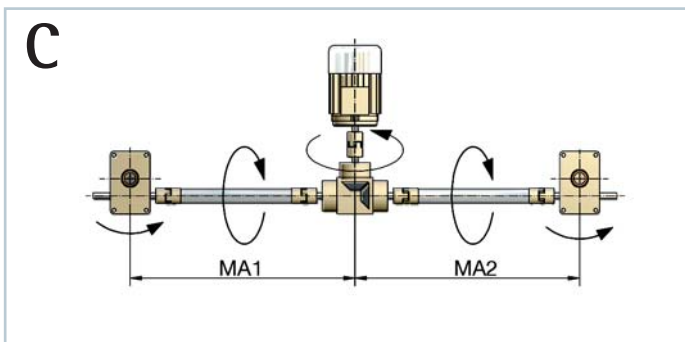
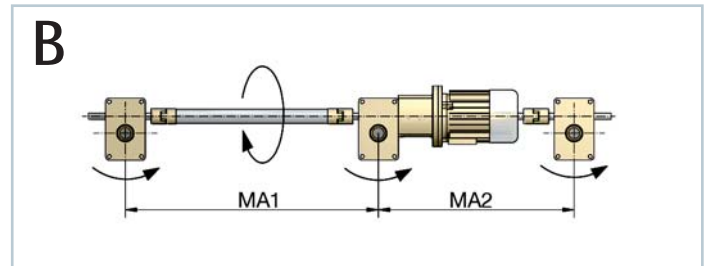
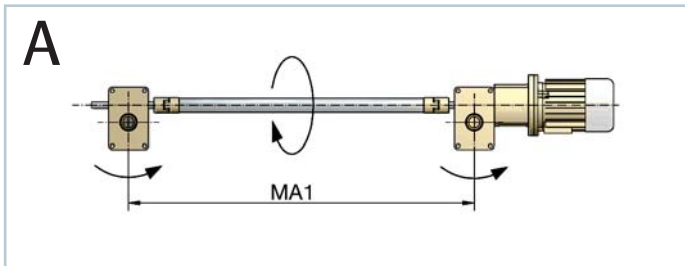
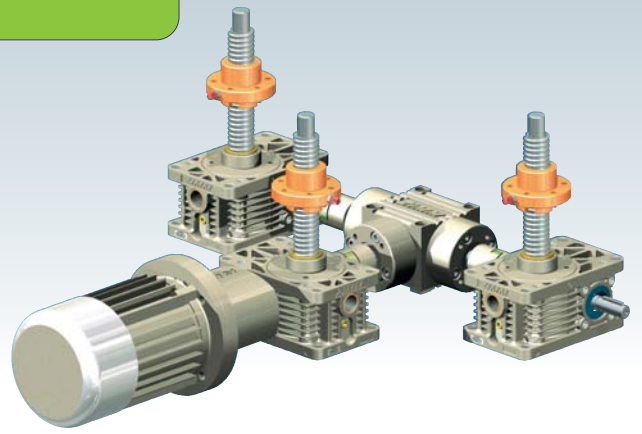

Checklist - Sheet 6 - System layouts

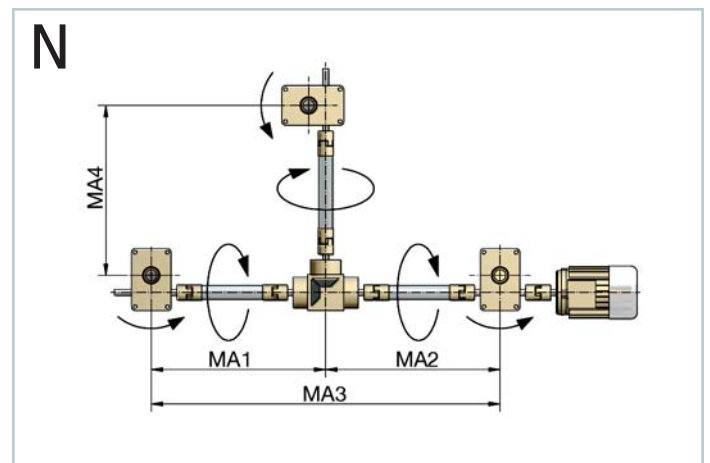
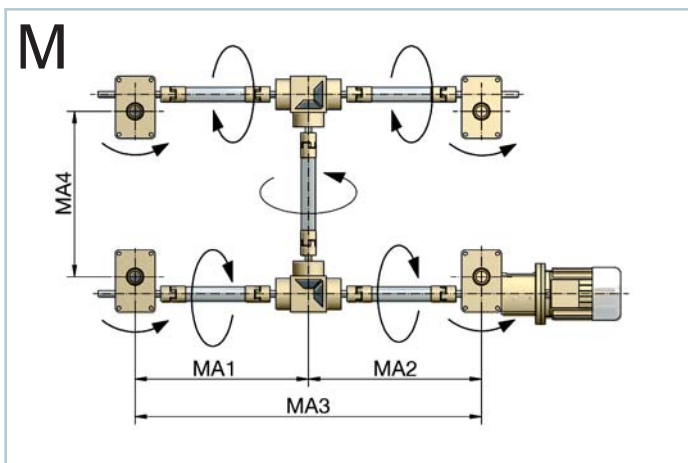
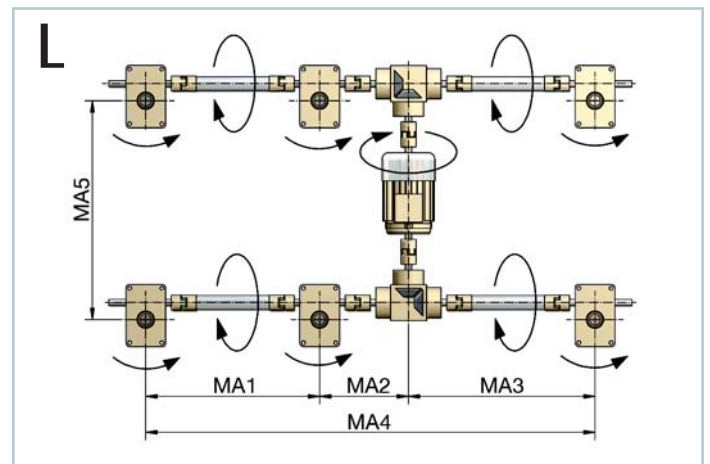
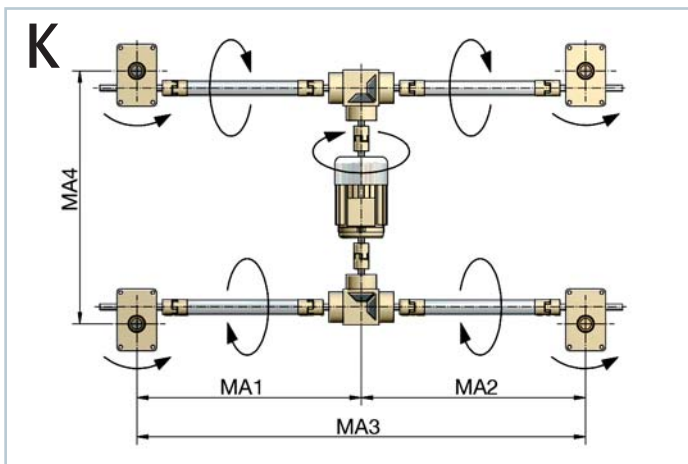
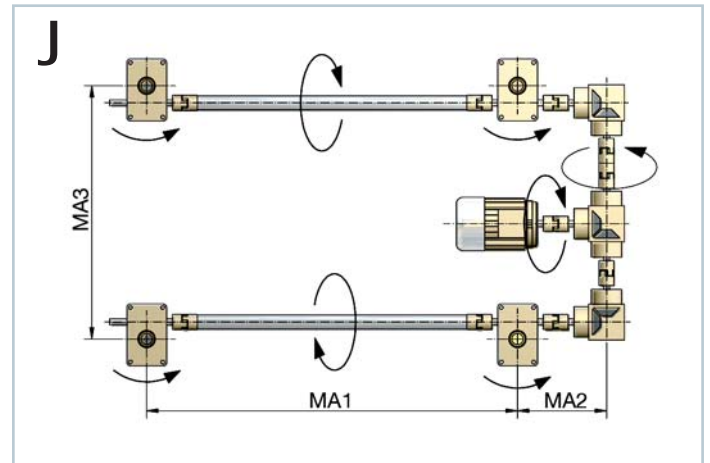
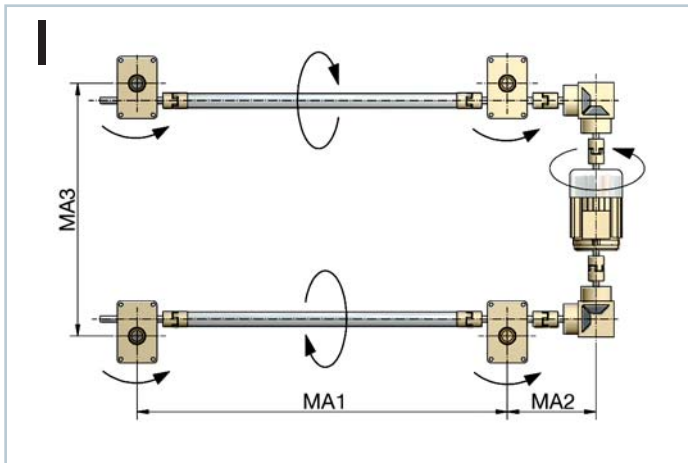

The most common layouts are shown. If your design is different, be sure to check the direction of rotation!